



**Winstar Display Co., LTD**

**華凌光電股份有限公司**



WEB: <http://www.winstar.com.tw>

E-mail: [winstar@winstar.com.tw](mailto:winstar@winstar.com.tw)

## SPECIFICATION

**CUSTOMER :** \_\_\_\_\_

**MODULE NO.:** WF70BSZAHLNTA#

<p align="center"><b>APPROVED BY:</b></p> <p>( FOR CUSTOMER USE ONLY )</p>	<p><b>PCB VERSION:</b> _____</p> <p><b>DATA:</b> _____</p>
--	--

SALES BY	APPROVED BY	CHECKED BY	PREPARED BY
			葉虹蘭
<b>ISSUED DATE: 2016/10/05</b>			

**RECORDS OF REVISION**

**DOC. FIRST ISSUE**

VERSION	DATE	REVISED PAGE NO.	SUMMARY
0	2016/09/14		First issue
A	2016/10/05		Modify Summary Add Aspect Ratio

# Contents

1.Module Classification Information

2.Summary

3.General Specification

4.Absolute Maximum Ratings

5.Electrical Characteristics

6.Operation Sequence

7.Optical Characteristics

8.Interface

9.Reliability

10.Touch Panel Information

11.Contour Drawing

12.Other

# 1.Module Classification Information

W F 70 B S Z A H L N T 0 #  
 ① ② ③ ④ ⑤ ⑥ ⑦ ⑧ ⑨ ⑩ ⑪ ⑫ ⑬

①	Brand : WINSTAR DISPLAY CORPORATION						
②	Display Type : F→TFT Type, J→Custom TFT						
③	Display Size : 7.0" TFT						
④	Model serials no.						
⑤	Backlight Type :	F→CCFL, White S→LED, High Light White			T→LED, White		
⑥	LCD Polarize Type/ Temperature range/ Gray Scale Inversion Direction	C→Transmissive, N. T, 6:00 ; I→Transmissive, W. T, 6:00 F→Transmissive, N.T,12:00 ; L→Transmissive, W.T,12:00 N→Transmissive, Super W.T, 6:00 Q→Transmissive, Super W.T, 12:00 X→Transmissive, W.T, VA TFT V→Transmissive, Super W.T, VA TFT R→Transmissive, Super W.T, O-TFT Z→Transmissive, W.T, O-TFT A→Transmissive, N.T, IPS TFT Y→Transmissive, W.T, IPS TFT					
⑦	A : TFT LCD B : TFT+FR+CONTROL BOARD C : TFT+FR+A/D BOARD D : TFT+FR+A/D BOARD+CONTROL BOARD E : TFT+FR+POWER BOARD F : TFT+CONTROL BOARD			G : TFT+FR H : TFT+D/V BOARD I : TFT+FR+D/V BOARD J : TFT+POWER BD			
⑧	Resolution:						
	A: 128160	B:320234	C:320240	D:480234	E:480272	F: 640480	G: 800480
	H:1024600	I:320480	J:240320	K:800600	L:240400	M :1024768	P :1280800
	S:480128	T:800320					
⑨	D: Digital L : LVDS						
⑩	Interface : N : without control board A : 8Bit B : 16Bit						
⑪	TS : N : Without TS T : resistive touch panel C : capacitive touch panel (G-F-F) G : capacitive touch panel(G-G)						
⑫	Version						
⑬	Special Code	#:Fit in with ROHS directive regulations					

## **2.Summary**

TFT 7.0”is a TN transmissive type color active matrix TFT liquid crystal display that use amorphous silicon TFT as switching devices. This module is a composed of a TFT\_LCD module, It is usually designed for industrial application and this module follows RoHs.

### **3. General Specifications**

<b>Item</b>	<b>Dimension</b>	<b>Unit</b>
Size	7.0	inch
Dot Matrix	1024 x RGBx600(TFT)	dots
Module dimension	169.9(W) x 103.4(H) x 7.0(D)	mm
Active area	154.2114 x 85.92	mm
Dot pitch	0.1506 x 0.1432	mm
LCD type	TFT, Normally White, Transmissive	
View Direction	12 o'clock	
Gray Scale Inversion Direction	6 o'clock	
Aspect Ratio	16:9	
Backlight Type	LED, Normally White	
With /Without TP	With RTP	
Interface	LVDS	
Surface	Anti-Glare	

\*Color tone slight changed by temperature and driving voltage.

## 4. Absolute Maximum Ratings

Item	Symbol	Min	Typ	Max	Unit
Operating Temperature	TOP	-20	—	+70	°C
Storage Temperature	TST	-30	—	+80	°C

Note: Device is subject to be damaged permanently if stresses beyond those absolute maximum ratings listed above

1. Temp.  $\leq 60^{\circ}\text{C}$ , 90% RH MAX. Temp.  $> 60^{\circ}\text{C}$ , Absolute humidity shall be less than 90% RH at  $60^{\circ}\text{C}$

# 5. Electrical Characteristics

## 5.1. Typical Operation Conditions

(Note 1)

Item	Symbol	Values			Unit	Remark
		Min.	Typ.	Max.		
Power voltage	DVDD	3.0	3.3	3.6	V	Note 2
	AVDD	9.4	9.6	9.8	V	
	VGH	17	18	19	V	
	VGL	-6.6	-6.0	-5.4	V	
Input signal voltage	VCOM	3.1	3.3	3.6	V	
Input logic high voltage	VIH	0.7 DVDD	-	DVDD	V	Note 3
Input logic low voltage	VIL	0	-	0.3 DVDD	V	

Note 1: Be sure to apply DVDD and VGL to the LCD first, and then apply VGH.

Note 2: DVDD setting should match the signals output voltage (refer to Note 3) of customer's system board.

Note 3: DCLK, HS, VS, RESET, U/D, L/R, DE, R0~R7, G0~G7, B0~B7, MODE, DITHB.

## 5.2. Current Consumption

Item	Symbol	Values			Unit	Remark
		Min.	Typ.	Max.		
Current for Driver	IGH	-	0.2	1.0	mA	VGH =18.0V
	IGL	-	0.2	1.0	mA	VGL = -6.0V
	IDVDD	-	4.0	10	mA	DVDD =3.3V
	IAVDD	-	20	50	mA	AVDD =9.6V



### 5.3. Backlight Driving Conditions

Item	Symbol	Values			Unit	Remark
		Min.	Typ.	Max.		
Voltage for LED backlight	VL	16.8	19.2	21.0	V	Note 1
Current for LED backlight	IL	--	320	--	mA	
LED life time	-	-	50,000	-	Hr	Note 2

Note 1: The LED Supply Voltage is defined by the number of LED at  $T_a=25^{\circ}\text{C}$  and  $I_L=320\text{mA}$ .

Note 2: The "LED life time" is defined as the module brightness decrease to 50% original brightness at  $T_a=25^{\circ}\text{C}$  and  $I_L=320\text{mA}$ . The LED lifetime could be decreased if operating  $I_L$  is larger than 320mA.

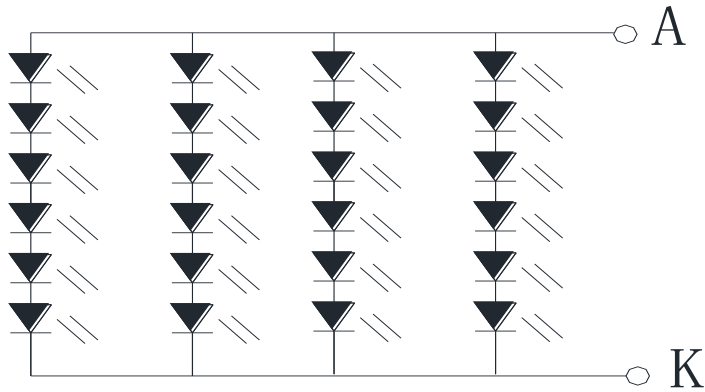

# 6. Operation Sequence

## 6.1. Power Sequence

In order to prevent IC from power on reset fail, the time (TPOR) of the digital power supply VDD should be maintained within the given specifications. Refer to “AC characteristics” for more detail on timing.

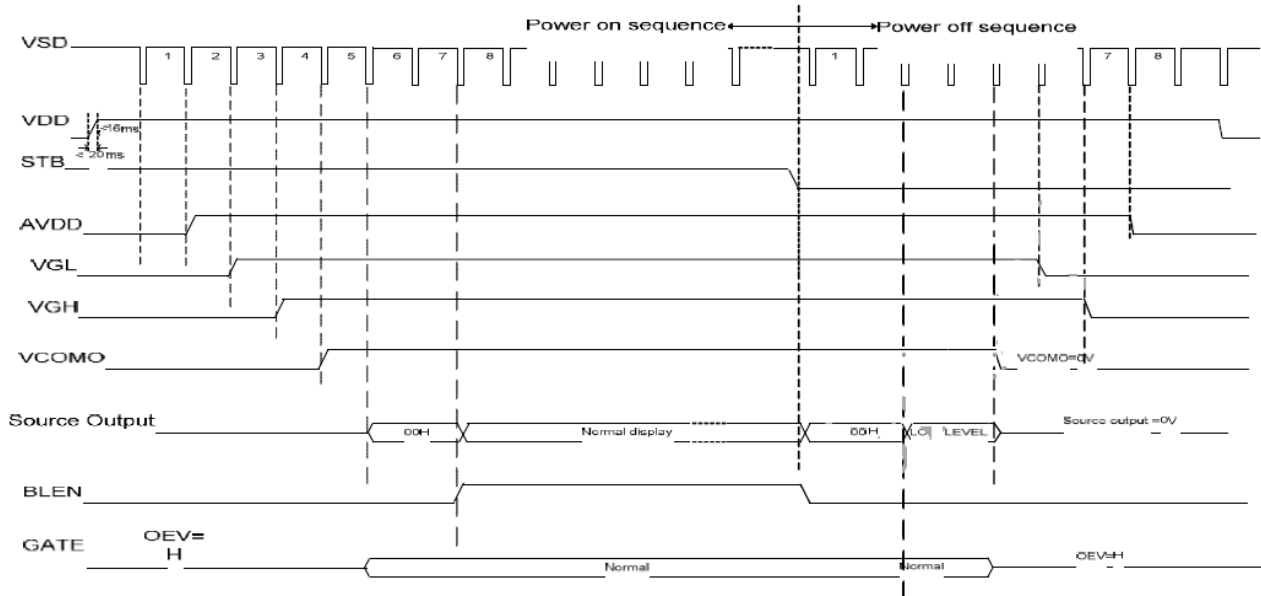

Power on/off timing chart

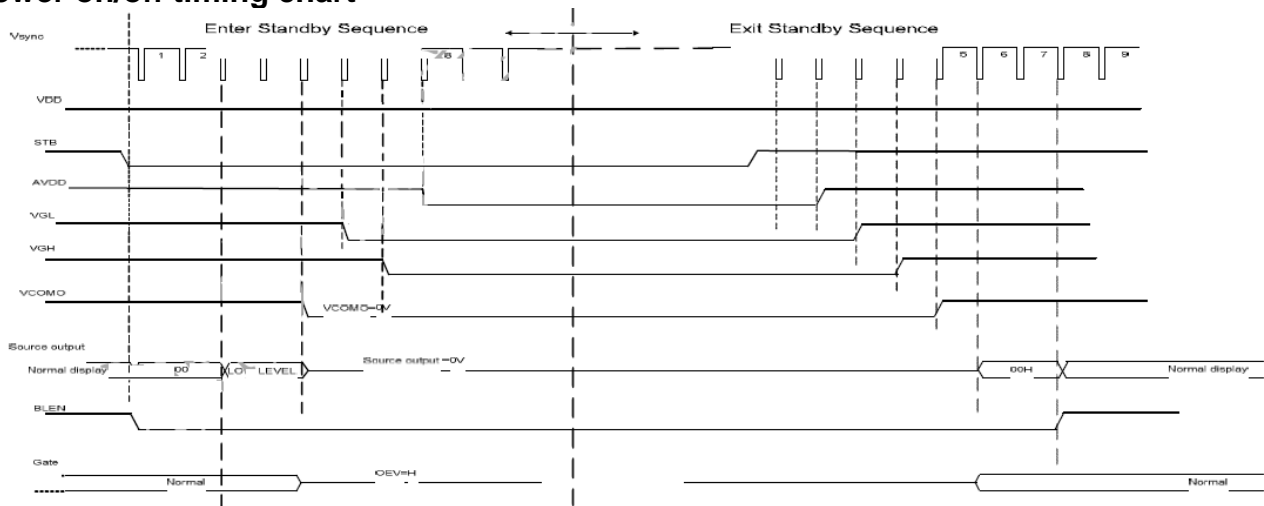

Enter and Exit standby Mode timing chart

Note : Low level=3Fh, when NBW=L (normally white)  
 Low level=00h, when NBW=H (normally black)

## 6.2. Timing Characteristics

### AC Electrical Characteristics

Parameter	Symbol	condition	Min.	Typ.	Max.	Unit
Clock frequency	R <sub>X</sub> FCLK		20	-	71	MHz
Input data skew margin	T <sub>RSKM</sub>	VID =400mV R <sub>x</sub> VCM=1.2V R <sub>x</sub> FCLK=71MHz	500	-	-	ps
Clock high time	T <sub>LVCH</sub>		-	4/(7* R <sub>x</sub> FCLK)	-	ns
Clock low time	T <sub>LVCL</sub>		-	3/(7* R <sub>x</sub> FCLK)	-	ns
PLL wake-up-time	T <sub>enPLL</sub>				150	us

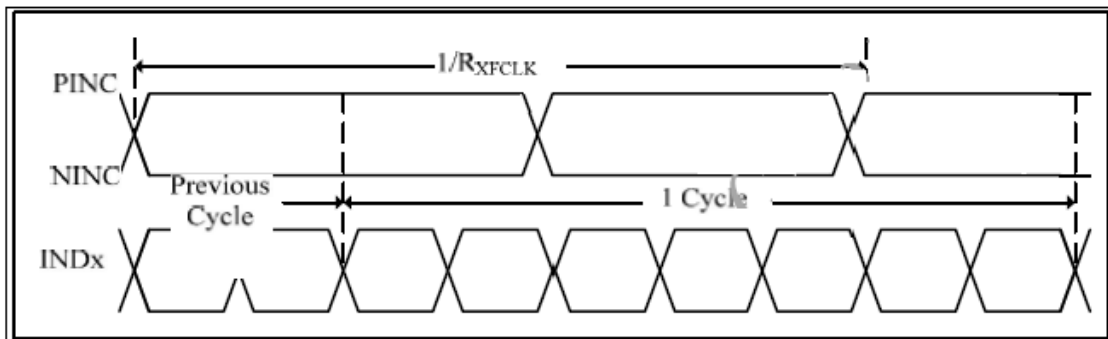

LVDS timing(1)

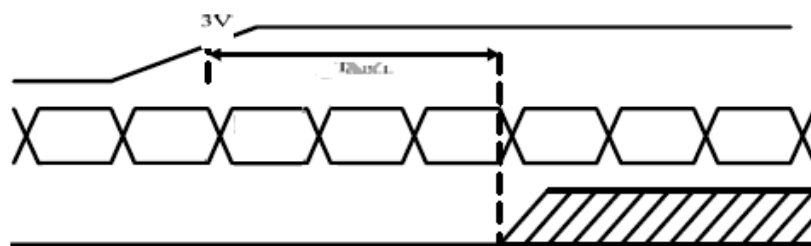

LVDS timing(2)

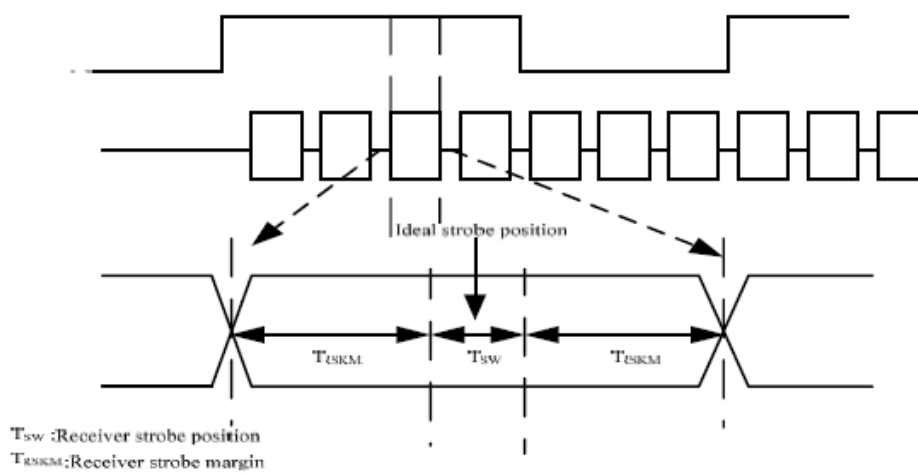

LVDS timing(3)



### 6.3. LVDS DC Characteristics

Parameter	Symbol	Min.	Typ.	Max.	Unit	Remark
Differential input high Threshold voltage	RxVTH	-	-	+0.1		
Differential input low Threshold voltage	RxVTL	-0.1	-	-	V	
Input voltage range (singled-end)	RxVIN	0	-	2.4	V	
Differential input common mode voltage	RxVCM	$ VID /2$	-	$2.4- VID /2$	V	
Differential input voltage	$ VID $	0.2	-	0.6	V	
Differential input leakage current	RVxliz	-10	-	+10	uA	
LVDS Digital operating Current	Iddlvsd	-	40(TBD)	50	mA	Fclk=65Mhz VDD=3.3V
LVDS Digital Standby Current	Istlvds	--	10(TBD)	50	uA	Clock & all Functions are stop

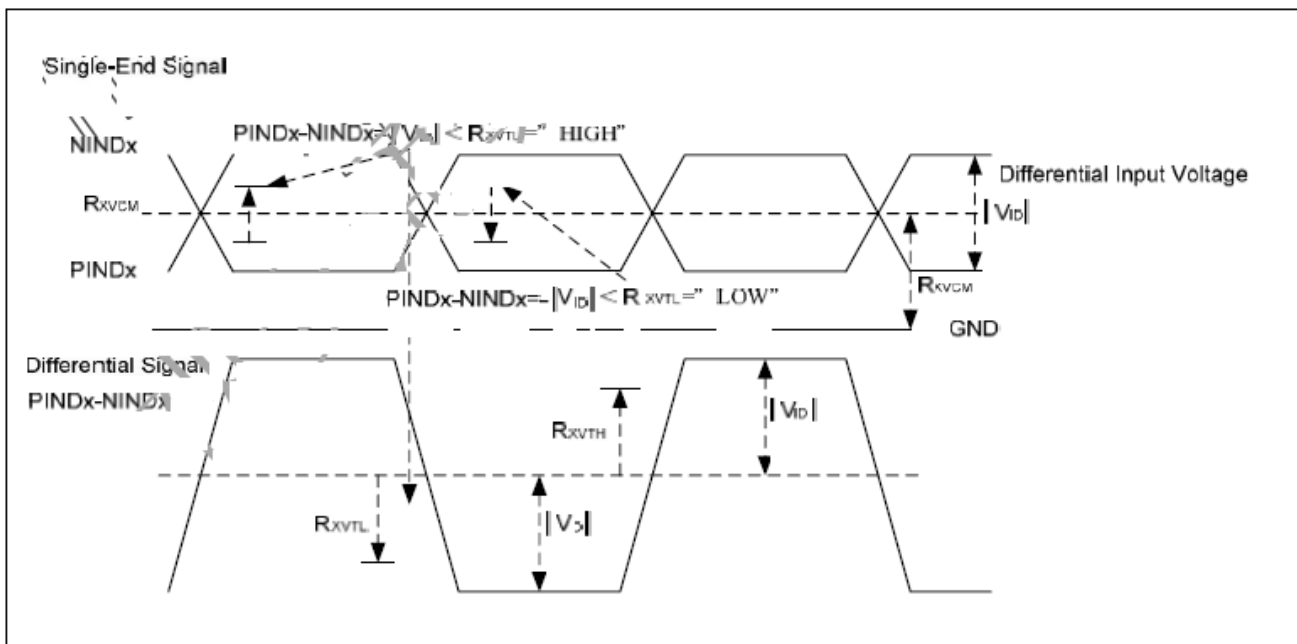

LVDS DC Characteristics

## Output Timing table

Parameter	Symbol	Min.	Typ.	Max.	Unit	Condition
DCLK frequency	Fclk	-	65	71	MHz	VDD =2.3~3.6V
DCLK cycle time	Tclk	14.1	15.4		ns	
DCLK pulse duty	Tcwh	40	50	60	%	Tclk
Time from HSD to Source Output	Thso	-	64	-	DCLK	
Time from HSD to LD	Thld	-	64	-	DCLK	
Time from HSD to STV	Thstv	-	2	-	DCLK	
Time from HSD to CKV	Thckv	-	20	-	DCLK	
Time from HSD to OEV	Thoev	-	4	-	DCLK	
LD pulse width	Twld	-	10	-	DCLK	
CKV pulse width	Twckv	-	66	-	DCLK	
OEV pulse width	Twoev	-	74	-	DCLK	

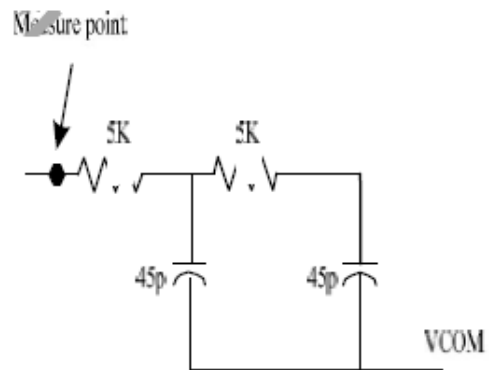
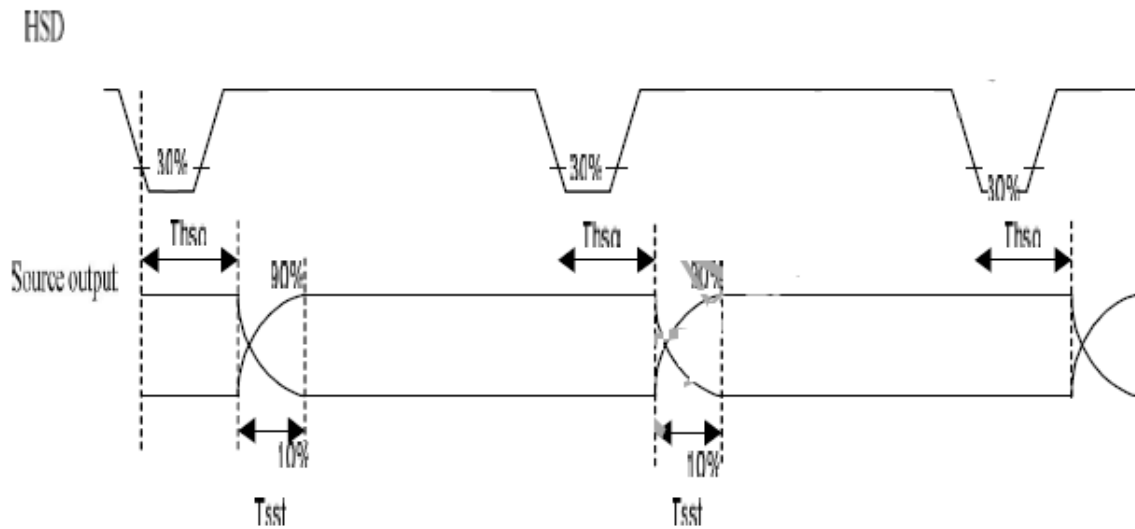

Source output timing (cascade)

**Data Input Format**  
**6bit LVDS input(HSD="H")**

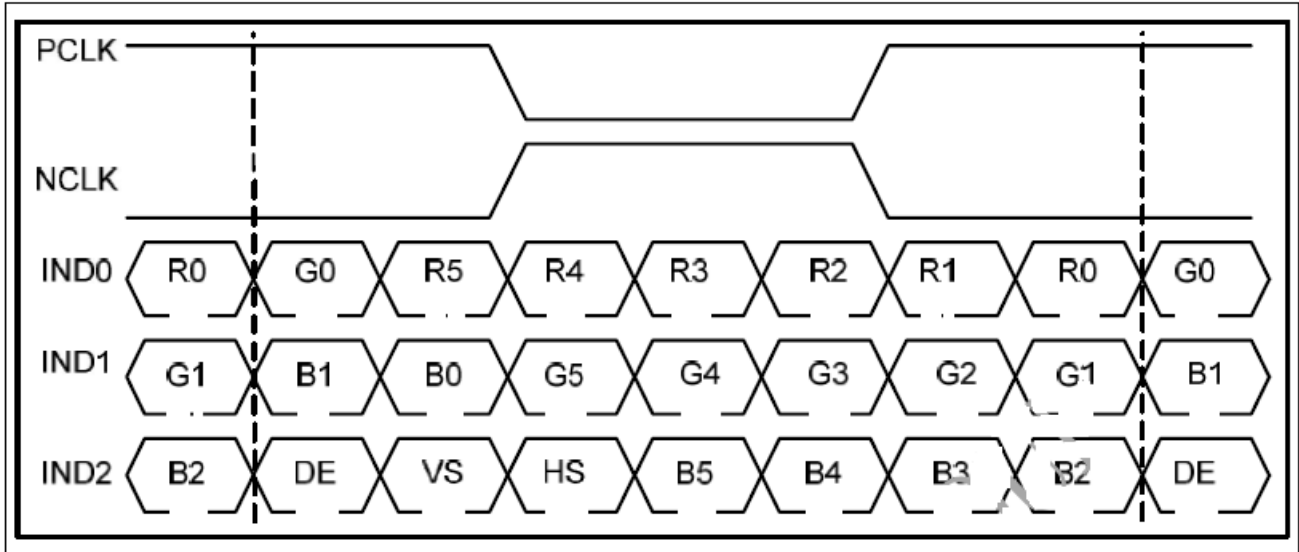

6-bit LVDS input timing chart

**8bit LVDS input(HSD="L")**

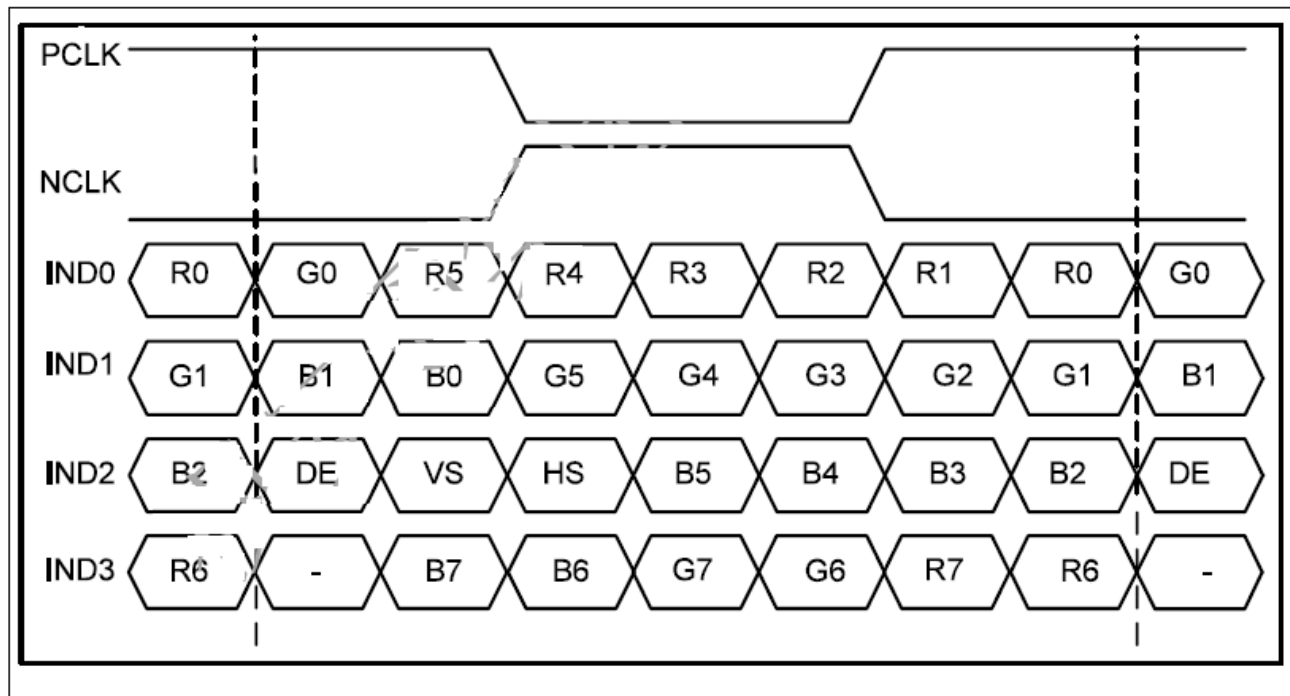

8-bit LVDS input timing chart

# 7. Optical Characteristics

Item	Symbol	Condition.	Min	Typ.	Max.	Unit	Remark	
Response time	Tr	$\theta=0^\circ, \Phi=0^\circ$	-	25	40	.ms	Note 3	
	Tf							
Contrast ratio	CR	At optimized viewing angle	600	800	-	-	Note 4	
Color Chromaticity	White	Wx	$\theta=0^\circ, \Phi=0^\circ$	0.26	0.31	0.36	-	Note 2,5,6
		Wy		0.28	0.33	0.38	-	
Viewing angle (Gray Scale Inversion Direction)	Hor.	$\Theta_R$	$CR \geq 10$	-	75	-	Deg.	Note 1
		$\Theta_L$		-	75	-		
	Ver.	$\Phi_T$		-	75	-		
		$\Phi_B$		-	75	-		
Brightness	-	-	550	600	-	cd/m <sup>2</sup>	Center of display	

Ta=25±2°C,

Note 1: Definition of viewing angle range

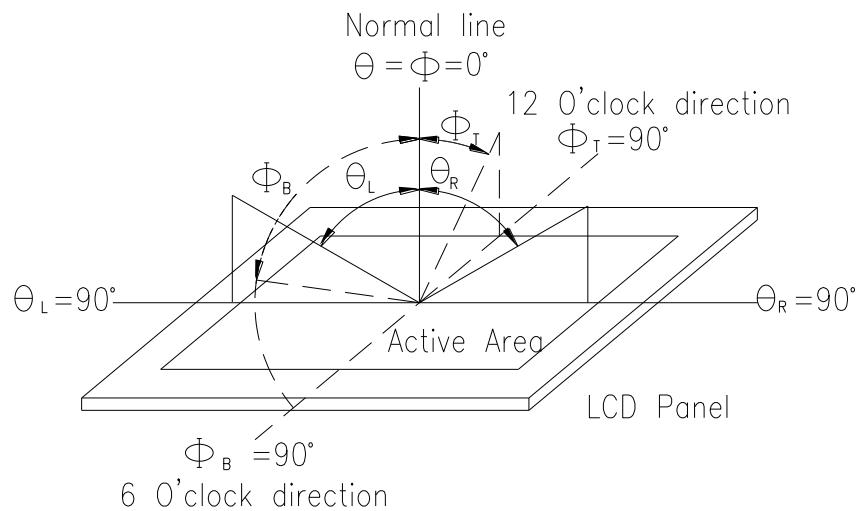

Fig. 7.1. Definition of viewing angle

Note 2: Test equipment setup:

After stabilizing and leaving the panel alone at a driven temperature for 10 minutes, the measurement should be executed. Measurement should be executed in a stable, windless, and dark room. Optical specifications are measured by Topcon BM-7 or BM-5 luminance meter 1.0° field of view at a distance of 50cm and normal direction.



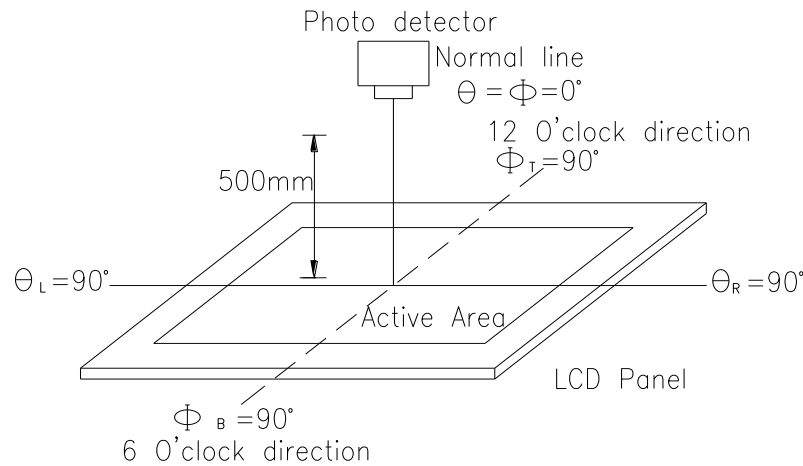
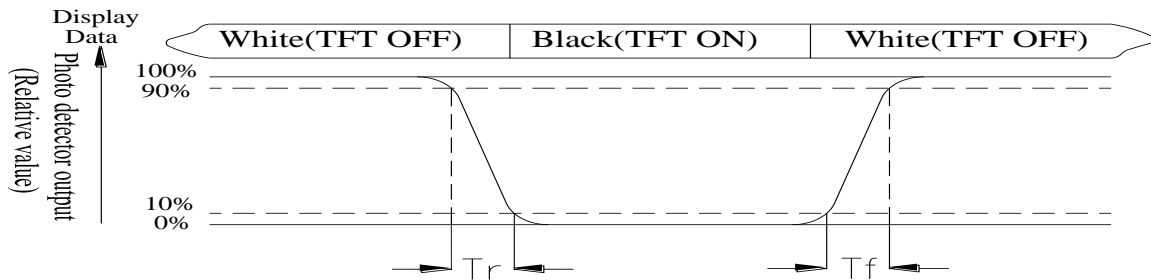

Fig. 7.2. Optical measurement system setup

Note 3: Definition of Response time:

The response time is defined as the LCD optical switching time interval between “White” state and “Black” state. Rise time,  $T_r$ , is the time between photo detector output intensity changed from 90% to 10%. And fall time,  $T_f$ , is the time between photo detector output intensity changed from 10% to 90%



Note 4: Definition of contrast ratio:

The contrast ratio is defined as the following expression.

$$\text{Contrast ratio (CR)} = \frac{\text{Luminance measured when LCD on the "White" state}}{\text{Luminance measured when LCD on the "Black" state}}$$

Note 5: White  $V_i = V_{i50} \pm 1.5V$

Black  $V_i = V_{i50} \pm 2.0V$

“±” means that the analog input signal swings in phase with VCOM signal.

“±” means that the analog input signal swings out of phase with VCOM signal.

The 100% transmission is defined as the transmission of LCD panel when all the input terminals of module are electrically opened.

Note 6: Definition of color chromaticity (CIE 1931)

Color coordinates measured at the center point of LCD

Note 7: Measured at the center area of the panel when all the input terminals of LCD panel are electrically opened.

# 8.Interface

## 8.1. LCM PIN Definition

FPC Connector is used for the module electronics interface. The recommended model is FH12A-40S-0.5SH manufactured by Hirose.

Pin No.	Symbol	I/O	Function	Remark
1	VCOM	P	Common Voltage	
2	VDD	P	Digital circuit	
3	VDD	P	Digital circuit	
4	NC	---	No connection	
5	Reset	I	Global reset pin	
6	STBYB	I	Standby mode, Normally pulled high STBYB = "1", normal operation STBYB = "0", timing controller, source driver will turn off, all output are High-Z	
7	GND	P	Ground	
8	RXIN0-	I	Negative LVDS differential data input	
9	RXIN0+	I	Positive LVDS differential data input	
10	GND	P	Ground	
11	RXIN1-	I	Negative LVDS differential data input	
12	RXIN1+	I	Positive LVDS differential data input	
13	GND	P	Ground	
14	RXIN2-	I	Negative LVDS differential data input	
15	RXIN2+	I	Positive LVDS differential data input	
16	GND	P	Ground	
17	RXCLKIN-	I	Negative LVDS differential clock input	
18	RXCLKIN+	I	Positive LVDS differential clock input	
19	GND	P	Ground	
20	RXIN3-	I	Negative LVDS differential data input	
21	RXIN3+	I	Positive LVDS differential data input	
22	GND	P	Ground	
23	NC	---	No connection	
24	NC	---	No connection	

25	GND	P	Ground	
26	NC	---	No connection	
27	DIMO	O	Backlight CABC controller signal output	
28	SELB	I	6bit/8bit mode select H:6bit / L:8bit	
29	AVDD	P	Power for Analog Circuit	
30	GND	P	Ground	
31	NC	---	No connection	
32	NC	---	No connection	
33	L/R	I	Horizontal inversion	
34	U/D	I	Vertical inversion	
35	VGL	P	Negative power for TFT	
36	GND	P	Ground	
37	GND	P	Ground	
38	VGH	P	Positive power for TFT	
39	NC	---	No connection	
40	NC	---	No connection	

I:input ,O:output,P:power

Note

When L/R="0",set right to left scan direction.

When L/R="1",set left to right scan direction.

When U/D="0",set top to bottom scan direction.

When U/D="1",set bottom to top scan direction.

# 9. Reliability

Content of Reliability Test (Wide temperature, -20°C ~70°C)

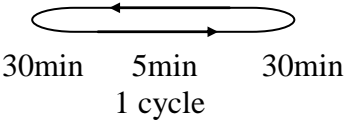
Environmental Test			
Test Item	Content of Test	Test Condition	Note
High Temperature storage	Endurance test applying the high storage temperature for a long time.	80°C 200hrs	2
Low Temperature storage	Endurance test applying the low storage temperature for a long time.	-30°C 200hrs	1,2
High Temperature Operation	Endurance test applying the electric stress (Voltage & Current) and the thermal stress to the element for a long time.	70°C 200hrs	—
Low Temperature Operation	Endurance test applying the electric stress under low temperature for a long time.	-20°C 200hrs	1
High Temperature/ Humidity Operation	The module should be allowed to stand at 60 °C, 90%RH max	60°C, 90%RH 96hrs	1,2
Thermal shock resistance	<p>The sample should be allowed stand the following 10 cycles of operation</p> <p style="text-align: center;">-20°C    25°C    70°C</p>  <p style="text-align: center;">30min    5min    30min 1 cycle</p>	-20°C /70°C 10 cycles	—
Vibration test	Endurance test applying the vibration during transportation and using.	Total fixed amplitude : 1.5mm Vibration Frequency : 10~55Hz One cycle 60 seconds to 3 directions of X,Y,Z for Each 15 minutes	3
Static electricity test	Endurance test applying the electric stress to the terminal.	VS=±600V(contact), ±800v(air), RS=330Ω CS=150pF 10 times	—

Note1: No dew condensation to be observed.

Note2: The function test shall be conducted after 4 hours storage at the normal Temperature and humidity after remove from the test chamber.

Note3: The packing have to including into the vibration testing.

# 10.Touch Panel Information

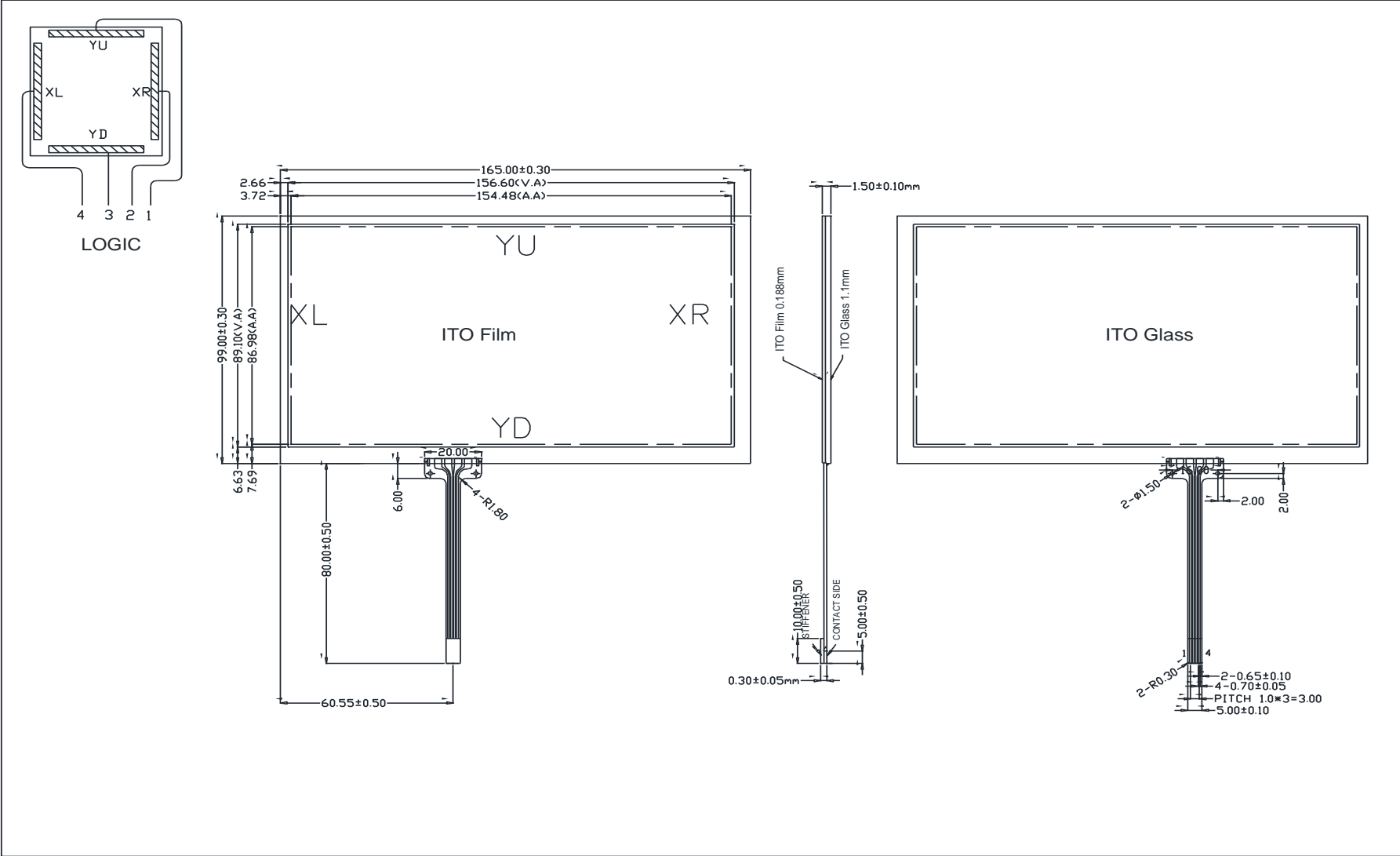

### 10.1. Resistance Touch Panel General Specifications

Item	Description
Driving condition	DC3~7V
Operating force	30~80g
Linearity max	$\leq \pm 1.5\%$
Insulating resistance	$> 10M\Omega$ , 25V(DC)
Light transparence	70%
Structure type	ITO Film/ITO Glass(F/G)
Surface Hardness	3H typ
Pen Hitting Durability (with the silicon rubber)	$> 1000,000$ times
X Axis resistance	430~910 $\Omega$
Y Axis resistance	150~530 $\Omega$

# 11. Contour Drawing

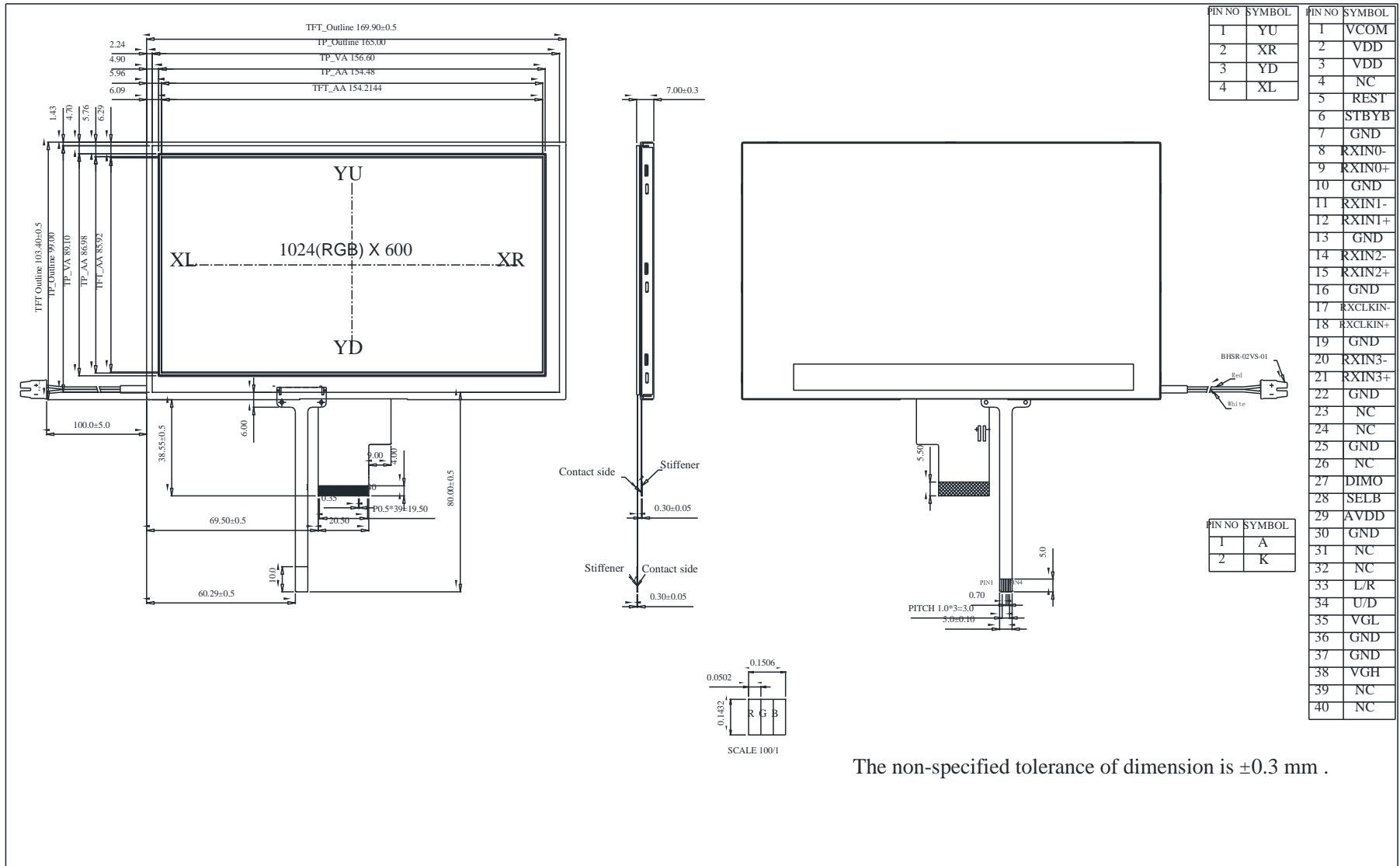

The non-specified tolerance of dimension is ±0.3 mm .



**1、Panel Specification :**

- 1. Panel Type :  Pass  NG , \_\_\_\_\_
- 2. View Direction :  Pass  NG , \_\_\_\_\_
- 3. Numbers of Dots :  Pass  NG , \_\_\_\_\_
- 4. View Area :  Pass  NG , \_\_\_\_\_
- 5. Active Area :  Pass  NG , \_\_\_\_\_
- 6. Operating Temperature :  Pass  NG , \_\_\_\_\_
- 7. Storage Temperature :  Pass  NG , \_\_\_\_\_
- 8. Others : \_\_\_\_\_

**2、Mechanical Specification :**

- 1. PCB Size :  Pass  NG , \_\_\_\_\_
- 2. Frame Size :  Pass  NG , \_\_\_\_\_
- 3. Material of Frame :  Pass  NG , \_\_\_\_\_
- 4. Connector Position :  Pass  NG , \_\_\_\_\_
- 5. Fix Hole Position :  Pass  NG , \_\_\_\_\_
- 6. Backlight Position :  Pass  NG , \_\_\_\_\_
- 7. Thickness of PCB :  Pass  NG , \_\_\_\_\_
- 8. Height of Frame to PCB :  Pass  NG , \_\_\_\_\_
- 9. Height of Module :  Pass  NG , \_\_\_\_\_
- 10. Others :  Pass  NG , \_\_\_\_\_

**3、Relative Hole Size :**

- 1. Pitch of Connector :  Pass  NG , \_\_\_\_\_
- 2. Hole size of Connector :  Pass  NG , \_\_\_\_\_
- 3. Mounting Hole size :  Pass  NG , \_\_\_\_\_
- 4. Mounting Hole Type :  Pass  NG , \_\_\_\_\_
- 5. Others :  Pass  NG , \_\_\_\_\_

**4、Backlight Specification :**

- 1. B/L Type :  Pass  NG , \_\_\_\_\_
- 2. B/L Color :  Pass  NG , \_\_\_\_\_
- 3. B/L Driving Voltage (Reference for LED Type) :  Pass  NG , \_\_\_\_\_
- 4. B/L Driving Current :  Pass  NG , \_\_\_\_\_
- 5. Brightness of B/L :  Pass  NG , \_\_\_\_\_
- 6. B/L Solder Method :  Pass  NG , \_\_\_\_\_
- 7. Others :  Pass  NG , \_\_\_\_\_

>> **Go to page 2** <<





Winstar      Module Number : \_\_\_\_\_

Page: 2

**5、Electronic Characteristics of Module :**

- 1. Input Voltage :                       Pass                       NG , \_\_\_\_\_
- 2. Supply Current :                       Pass                       NG , \_\_\_\_\_
- 3. Driving Voltage for LCD :            Pass                       NG , \_\_\_\_\_
- 4. Contrast for LCD :                     Pass                       NG , \_\_\_\_\_
- 5. B/L Driving Method :                 Pass                       NG , \_\_\_\_\_
- 6. Negative Voltage Output :           Pass                       NG , \_\_\_\_\_
- 7. Interface Function :                  Pass                       NG , \_\_\_\_\_
- 8. LCD Uniformity :                     Pass                       NG , \_\_\_\_\_
- 9. ESD test :                             Pass                       NG , \_\_\_\_\_
- 10. Others :                               Pass                       NG , \_\_\_\_\_

**6、Summary :**

Sales signature : \_\_\_\_\_

Customer Signature : \_\_\_\_\_

Date :        /        /        \_\_\_\_\_