



CA9



CE9

Carbon
Potentiometers
CA

Cermet
Potentiometers
CE

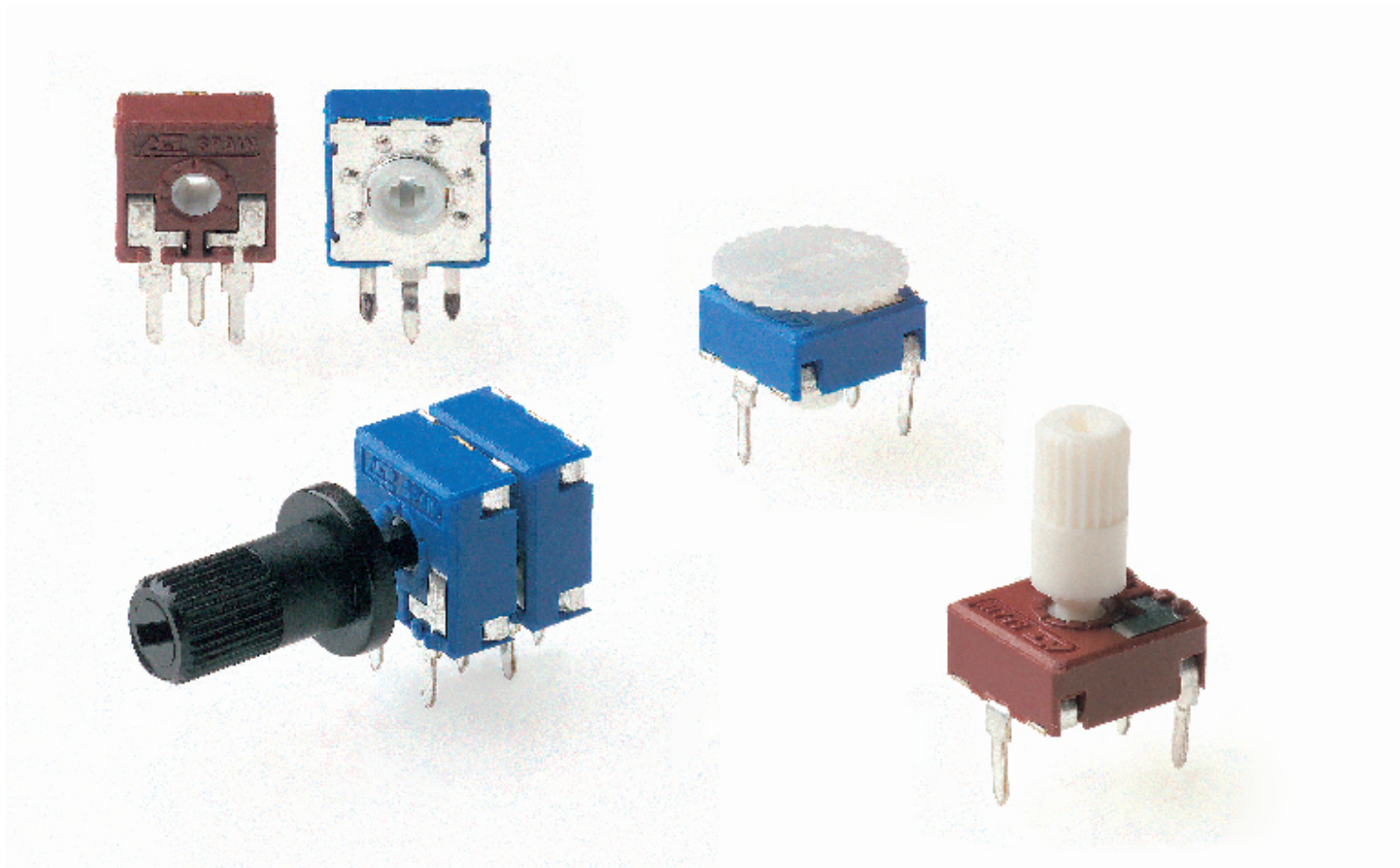



9mm carbon potentiometers with plastic housing and protection type IP 5 (dust-proof).

Standard tapers available include linear, log and antilog. ACP can also study special requests.

Terminals are manufactured in tinned brass to guarantee better soldering and higher resistance to corrosion. They can be provided straight or crimped (with “snap in”), recommended to hold the potentiometer to the board prior to the soldering operation. SMD configuration can be available on request.

Thumbwheels and shafts can be provided either separately or already inserted in the potentiometer.

ACP's potentiometers can be adjusted from either side, both in the horizontal and the vertical adjustment types. There is a guide on the housing to simplify the manual adjusting operations.

Our potentiometers can be manufactured in a wide range of possibilities regarding:

- Resistance value.
- Tolerance.
- Tapers / variation laws.
- Pitch.
- Positioning of the wiper (the standard is at 50%).
- Housing and rotor color.
- Mechanical life.
- Pause effect (up to 20 detents available).
- Self-extinguishable plastic parts according to UL 94 V-0.

Applications

- Electronic appliances: white goods, brown goods, small household appliances.
- Heating and air conditioning equipment and thermostats.
- Automotive: dimmers, climate controls, lighting regulation (position adjustment and sensing).
- Measurement and test equipment. Timers and relays.
- Multimedia.



9mm Cermet potentiometers with plastic housing and protection type IP 5 (dust-proof). Self-extinguishable according to UL 94 V-0.

Standard taper is linear. Log, Antilog and other tapers are available on request. Laser trimming equipment in-house, allowing for very low tolerances.

Terminals are manufactured in tinned brass to guarantee better soldering and higher resistance to corrosion. They can be provided straight or crimped (with “snap in”), recommended to hold the potentiometer to the board prior to the soldering operation. SMD configuration can be available on request.

Thumbwheels and shafts can be provided either separately or already inserted in the potentiometer.

ACP's potentiometers can be adjusted from either side, both in the horizontal and the vertical adjustment types. There is a guide on the housing to simplify the manual adjusting operations.

Our potentiometers can be manufactured in a wide range of possibilities regarding:

- Resistance value.
- Tolerance.
- Tapers / variation laws.
- Pitch.
- Positioning of the wiper (the standard is at 50%).
- Housing and rotor color.
- Mechanical life.
- Pause effect (up to 20 detents available).

Applications

- Electronic appliances: white goods, brown goods, small household appliances, boilers, water heaters, etc.
- Heating and air conditioning equipment and thermostats.
- Automotive: dimmers, climate controls, lighting sensors.
- Industrial electronics: multimeters, oscilloscopes, test equipment, time relay.

Models

All models shown here have the standard rotor for the 9mm series, the arrow (P). Models can be manufactured with any of the rotors listed on the rotor menu. The color of the housing or rotor can also be modified. SMD configuration can be available on request.

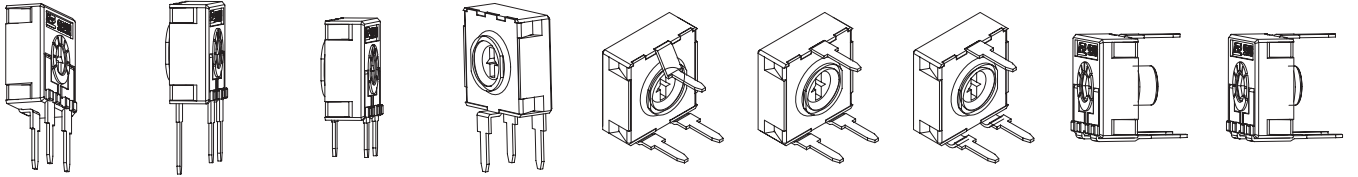

CA9 H2,5 CE9 H2,5 CA9 H3,8 CE9 H3,8 CA9 HS3,8 CE9 HS3,8 CA9 H5 CE9 H5 CA9 V7,5 CE9 V7,5 CA9 V10 CE9 V10 CA9 VR10 CE9 VR10 CA9 MAV10 CE9 MAV10 CA9 MTV10 CE9 MTV10

Rotors

The rotor by default is the arrow (P). Accessories are designed for the M and J rotors, unless otherwise stated.

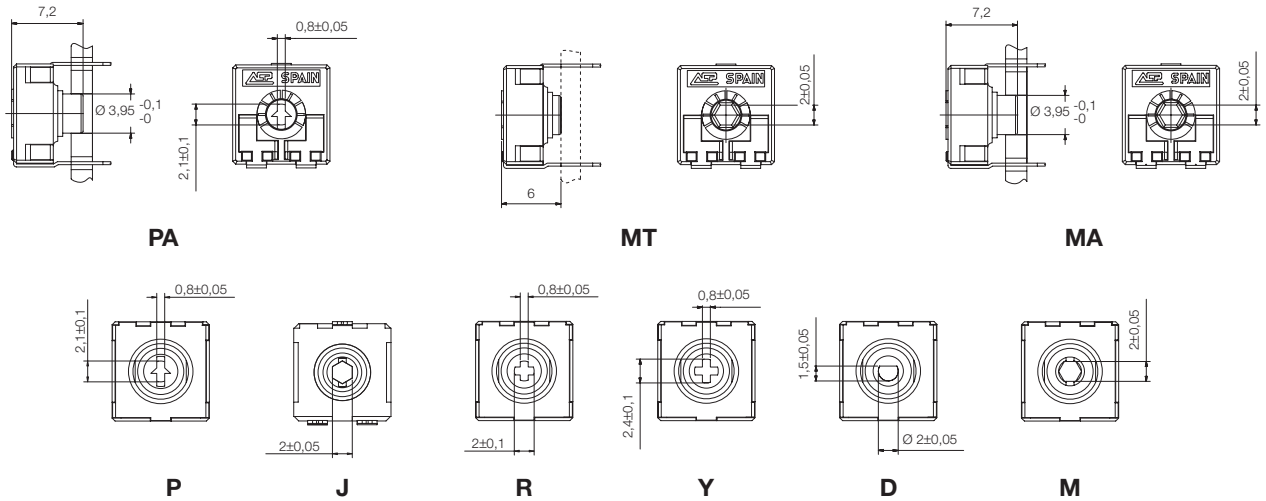

Shafts

• **CA9.** Shafts are available in different colors. On request, they can also be provided in accordance with UL 94 V-0. Potentiometers can be supplied with shafts already inserted in. ACP can also study special shafts.

• **CE9.** Shafts in accordance with UL 94 V-0 are available in different colors. Potentiometers can be supplied with shafts already inserted in. ACP can also study special shafts.

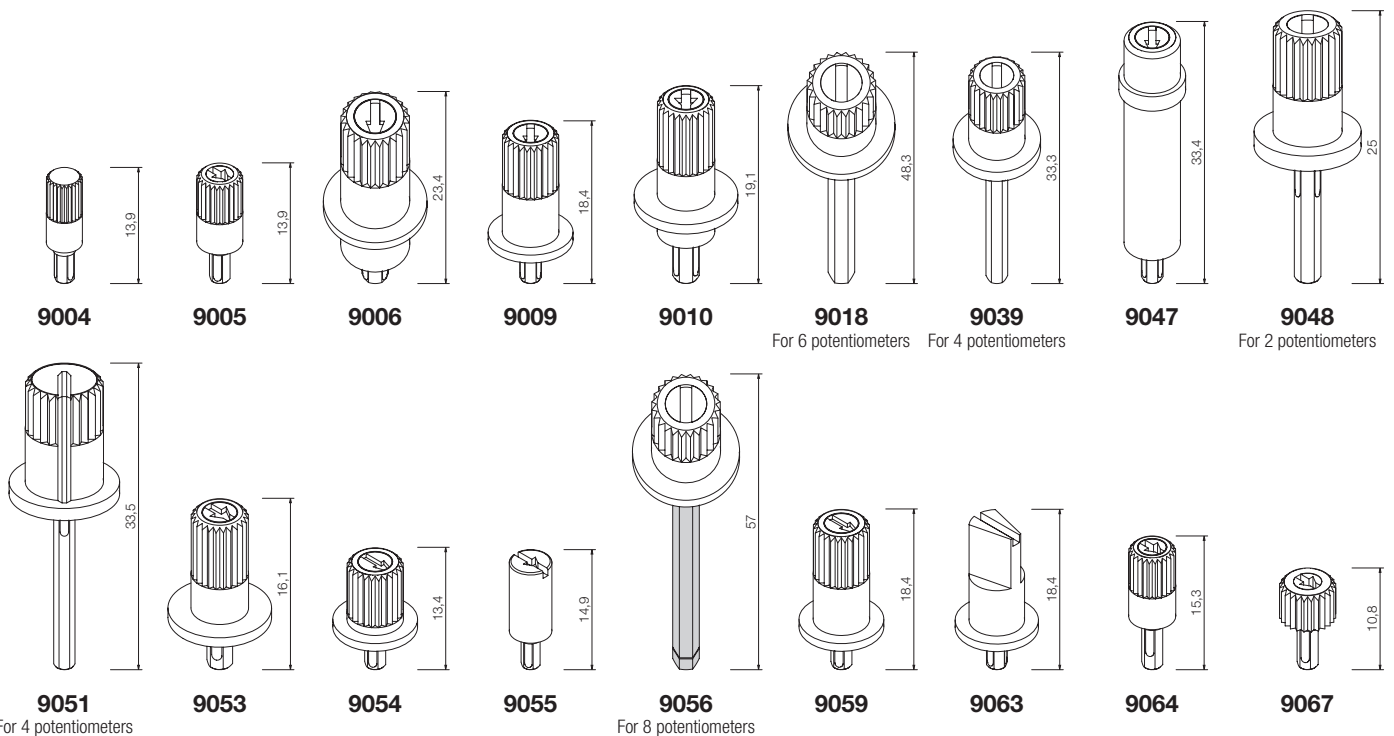

Thumbwheels

• **CA9.** Thumbwheels are available in different colors. On request, they can also be provided in accordance with UL 94 V-0. Potentiometers can be supplied with thumbwheels already inserted in. ACP can also study special requests for thumbwheels.

• **CE9.** Thumbwheels in accordance with UL 94 V-0 are available in different colors. Potentiometers can be supplied with thumbwheels already inserted in. ACP can also study special requests for thumbwheels.

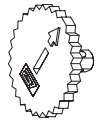

9002

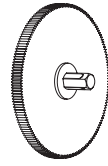

9041

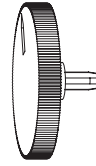

9060
For R rotor

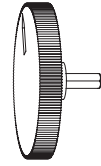

9061

Terminals

By default, terminals are always straight for the 9mm size, as shown on the “models” menu. ACP can provide crimped terminals (with “snap in”), to better hold the component to the board prior to soldering.

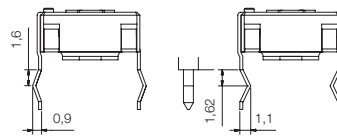

SNP

SNJ

Adjustment possibilities

ACP's potentiometers can be adjusted through either the front side (WT) or the collector side (WTI):

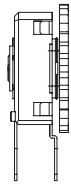

WTI
Collector side

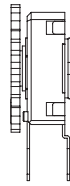

WT
Front side

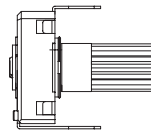

WTI
Collector side

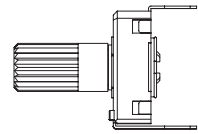

WT
Front side

Potentiometers with detents

ACP's “detent” feature (DT) is specially suitable for control applications. Our patented design has improved the features of these potentiometers:

- Longer mechanical life: up to 10.000 cycles.
- More stable electrical parameters.
- Improved reliability and Contact Resistance Variation (CRV).
- Narrower tolerances for detent positioning.

Detents can be lighter or stronger, or even a combination of both feelings. Detents can be evenly distributed along the angle (standard), or tailored to match customers' request. They can also be combined with special tapers: constant value areas, different slopes, etc.

Examples: 4, 6 and 20 detents –evenly distributed–.

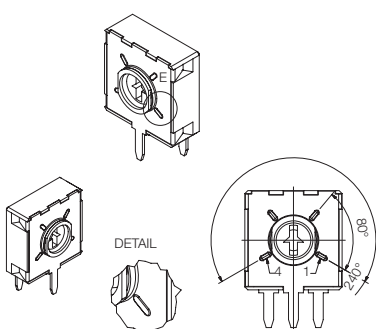

4DT

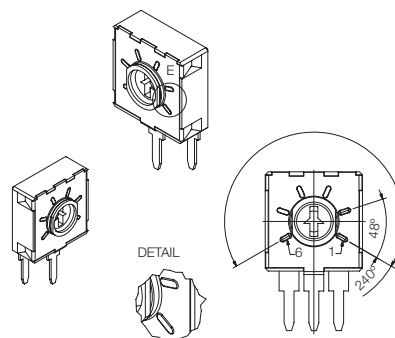

6DT

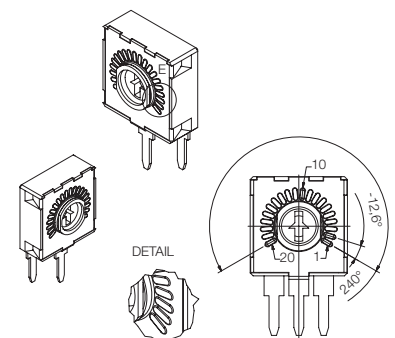

20DT

Potentiometers with cut track

The resistive element in this potentiometer has an area with very high resistive values, resulting in an open circuit. Recommended for lighting regulation.

With cut at the beginning of the track CCW: Off-On.

With cut at the end of track CW: On-Off. Other positions available on request.

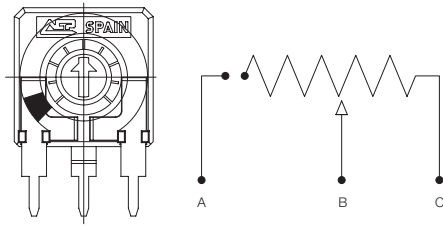

CCW: Off-On

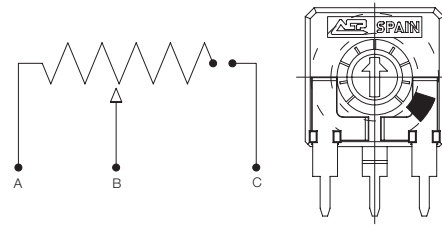

CW: On-Off

Assemblies of several potentiometers

STACKING: Set of 6 potentiometers in a plastic cover. It is used to speed up assembly and soldering process.

GANGED: Set of potentiometers in a row that allows for simultaneous adjustment of all of them through one shaft. Recommended potentiometer model is H2,5. MTX2 (2 potentiometers), MTX4 (4), MTX6 (6), MTX8 (8).

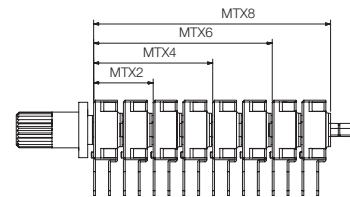
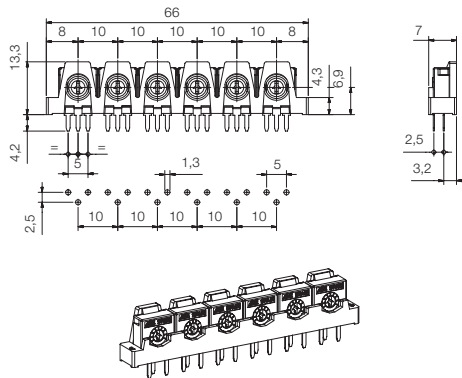

Packaging

Bulk packaging: Potentiometers are first bagged and then introduced in boxes:

Potentiometer model	+ Shaft or thumbwheel inserted	Pieces per box (130 x 60 x 90)
	- (only potentiometers)	500 (models with * : 450)
H2,5 - H3,8 - H5 - HS3,8 - V7,5 - V10 - VR10 MAV10* - MTV10*	9002	250
	9004, 9005, 9006, 9009, 9010, 9018, 9039, 9041, 9047, 9048, 9051, 9056, 9059, 9053, 9054, 9055, 9060, 9061, 9063, 9064, 9067	200
MTX2	9048	150
MTX4	9039, 9051	75
MTX6	9018	50
MTX8	9056	40
STACKING	-	50

Tape and reel (T&R) packaging will be available for SMD configurations, on request.



CA9. Electric Specifications

These are standard features; other specifications can always be studied on request.

Range of resistance values Lin (A) Log (B) Antilog (C)	$100\Omega \leq R_n \leq 5M\Omega$ 1 K Ω ... 2,2 M Ω
Tolerance Special tolerances available on request	100 Ω ... 1M Ω $\pm 20\%$ >1M Ω ... 5M Ω $\pm 30\%$ Out of range: R _n > 5M Ω : +50%, -30%
Variation laws	Lin (A), Log (B), Antilog (C) Other tapers available on request
Residual resistance	Lin (A), Log (B), Antilog (C) $\leq 5 \cdot 10^{-3} R_n$ Minimum value 2 Ω
CRV - Contact Resistance Variation (dynamic)	$\leq 3\% R_n$
CRV - Contact Resistance Variation (static)	$\leq 5\% R_n$
Maximum power dissipation at 40° C. Lin (A) Non Lin (B, C)	0,15W 0,10W
Maximum voltage at 40° C. Lin (A) Non Lin (B, C)	200VDC 150VDC
Operating temperature	-25°C ... +70°C
Temperature coefficient	100 Ω - 10K Ω \rightarrow +200/ -300 ppm. >10K Ω - 5M Ω \rightarrow +200/ -500 ppm



CA9. Mechanical Specifications

Resistive element	Carbon technology
Angle of rotation (mechanical)	240° \pm 5°
Wiper position	Middle position: 50% \pm 15°
Angle of rotation (electrical)	220° \pm 20°
Max. stop torque	5 Ncm
Max. push/pull on rotor	40 N
Wiper torque	< 2 Ncm (0,4 ... 3,5Ncm for pots. with detents)
Mechanical life	1000 cycles (more available on request) (up to 10.000 cycles for pots. with detents)



CA9. Test

Test // Conditions // Typical variation of Nominal Resistance

Damp heat // 500 h. at 40°C and 95% RH // +5%; -2%
Thermal cycles // 16h at 85°C, plus 2h at -25°C // $\pm 2,5\%$
Load life // 1.000 h. at 40°C // +0%; -5%
Mechanical life // 1000 cycles at 10 c.p.m. and at 23°C \pm 2°C // $\pm 3\%$
Soldering effect // 2 seconds at 350°C // $\pm 1\%$
Storage (3 years) // at 23°C \pm 2°C // $\pm 3\%$
For further information on tests, go to TESTS AND RELIABILITY on pages 10-11.

All specifications are given at 23°C \pm 2°C and 50% \pm 25% RH.



CE9. Electric Specifications

These are standard features; other specifications can always be studied on request.

Range of resistance values Lin (A) Log (B) Antilog (C)	$100\Omega \leq R_n \leq 5M\Omega$ 1 K Ω ... 2,2 M Ω
Tolerance Special tolerances available on request	100 Ω ... 1M Ω $\pm 20\%$ >1M Ω ... 5M Ω $\pm 30\%$ Out of range: R _n > 5M Ω : +50%, -30%
Variation laws	Lin (A) Log (B), Antilog (C) and other tapers available on request
Residual resistance	Lin (A), Log (B), Antilog (C) $\leq 5 \cdot 10^{-3} R_n$ Minimum value 2 Ω
CRV - Contact Resistance Variation (dynamic)	$\leq 3\% R_n$
CRV - Contact Resistance Variation (static)	$\leq 5\% R_n$
Maximum power dissipation at 40° C. Lin (A) Non Lin (B, C)	0,5W See note 1
Maximum voltage at 40° C. Lin (A) Non Lin (B, C)	200VDC See note 1
Operating temperature	-40°C ... +125°C
Temperature coefficient	± 100 ppm.

Note 1: Value depends on taper, please, inquire.



CE9. Mechanical Specifications

Resistive element	Cermet technology
Angle of rotation (mechanical)	240° \pm 5°
Wiper position	Middle position: 50% \pm 15°
Angle of rotation (electrical)	220° \pm 20°
Max. stop torque	5 Ncm
Max. push/pull on rotor	40 N
Wiper torque	< 2 Ncm (0,4 ... 3,5Ncm for pots. with detents)
Mechanical life	1000 cycles (more available on request) (up to 10.000 cycles for pots. with detents)



CE9. Test

Test // Conditions // Typical variation of Nominal Resistance

Damp heat // 500 h. at 40°C and 95% RH // $\pm 2\%$
Thermal cycles // 16h at 90°C, plus 2h at -40°C // $\pm 2\%$
Load life // 1.000 h. at 70°C // $\pm 2\%$
Mechanical life // 1000 cycles at 10 c.p.m. and at 23°C \pm 2°C // $\pm 2\%$
Soldering effect // 2 seconds at 350°C // $\pm 1\%$
Storage (3 years) // at 23°C \pm 2°C // $\pm 3\%$
For further information on tests, go to TESTS AND RELIABILITY on pages 10-11.

- **EXAMPLE: CA9MH2,5-10KA2020 SNP PI WT9005-BA-V0**
- **EXAMPLE: CE9MH2,5-10KA2020 SNP PI WT9005-BA-V0**

Standard features								Extra features							Assembled accessory			
Series	Rotor	Model	Packg	Ohm value	Taper	Tol	Life	Track	Detents	Snap in	Housing	Rotor	Wiper	Lin	Assembly	Ref #	Color	Flam.
1	2	3	4	5	6	7	8	9	10	11	12	13	14	15		16		17
CA9/CE9	M	H2,5		-10K	A	2020				SNP			PI		WT	9005	-BA	-V0

Standard configuration		Customized products	
Dimensions:	9mm	A drawing is requested to order a customized product. The code assigned will include all special specifications.	
Protection:	<ul style="list-style-type: none"> • CA9: IP 5 (dust-proof) • CE9: IP-5 (dust-proof) Self-extinguishable, to meet UL 94 V-0 		
Substrate:	<ul style="list-style-type: none"> • CA9: Carbon technology • CE9: Cermet 	Series, rotor, model and total resistive value are given before the special code: CA9PH2,5 10K CODE C00111.	
Color:	<ul style="list-style-type: none"> • CA9: Blue housing with white rotor • CE9: Brown housing with white rotor 		
Packaging:	Bulk		
Wiper position:	at 50° ±15°		
Terminals:	Straight, without SNAP IN		
Marking:	Resistive value marked on housing. Others on request		

1 - Series

- CA9
- CE9

3 - Model and pitch

H2,5	H3,8	H5	HS3,8	V7,5
V10	VR10	MAV10	MTV10	

HSMD and VSMD models can be available on request.

5 - Resistance value

Taper:	Lin (A)	Log (B), Antilog (C)
Value Rn	100 Ω / 100 ... / ... 5 MΩ / 5M	1KΩ / 1K ... / ... 2,2 MΩ / 2M2

Other resistive values available on request.

7 - Tolerance

100 Ω ≤ Rn ≤ 1MΩ: ±20%	2020
1 MΩ ≤ Rn ≤ 5MΩ: ±30%	3030
For out of range values: Rn > 5MΩ, tol : +50% - 30%	5030

Special tolerances available: <5% ... 10%, etc.

9 - Cut track

At beginning of track, CCW: Off - On	PCI
At end of track, CW: On - Off	PCF

11 - Crimped terminals (SNAP IN)

SNAP IN P	SNP
SNAP IN J	SNJ

2 - Rotors

P (standard)	PA	R	Y	D	M	MA	MT	J
--------------	----	---	---	---	---	----	----	---

4 - Packaging

	Through-hole	SMD models
Bulk	(blank)... ⁽¹⁾	On request
T&R (Tape and reel)	(N.A.) ⁽²⁾	On request

(1) If blank, bulk packaging is implied.

(2) N.A. - Not Available: Tape and Reel packaging is only available for SMD terminals.

6 - Resistance law / taper

Lin - Linear	A
Log - Logarithmic	B (on request for CE)
Antilog - Antilogarithmic	C (on request for CE)
- Special tapers have codes assigned:	CODE YXXXXX

Please, indicate terminal position when ordering a special taper.

8 - Operating life (cycles)

Standard (1000cycles)	(leave blank)
Long life: LV + the number of cycles. ex: LV10 for 10000 cycles ⁽¹⁾	LVXX: ex: LV10

(1) Others on request.

10 - Detents (DT)

One detent at the beginning: CCW	DTI
One detent at the end: CW	DTF
X number of detents. Ex., 10	XDT: 10DT

Detents readily available: 3, 4, 6, 7, 9, 10, up to 20 –evenly distributed along 240°±5°. Others on request.

12 - Housing color

- **CA9:** standard is blue
- **CE9:** standard is brown

With other colors -see color chart below-, for example, red CJ-color, ex: CJ-R0

13 - Rotor color

Standard is white	
With other colors -see color chart below-, for example, red	RT-color; ex: RT-RO

15 - Linearity

Independent linearity controlled & below x%, for example, 3%: LN3%	LNx%; ex: LN3%
Absolute linearity controlled & below x%	LAx%

17 - Flammability (according to UL 94 V-0)

• CA9: Not self-extinguishable	(leave blank)
Self-extinguishable according to standard UL 94 (including all plastic parts of the potentiometer: rotor, housing and accessory. If only one part needs to be V0, please, inform)	-V0
• CE9: All accessories assembled with cermet potentiometers will have the self-extinguishable property according to standard UL 94	-V0

For ordering spare accessories

Accessory reference - color- flammability. Ex. 9005-AZ-V0 is a blue self-extinguishable 9005 thumbwheel	XXXX-YY-__
---	------------

For ordering special sets of potentiometers

STACKING	STK + ... (POTENTIOMETER CODE)	Example: STK+CA9MH2,5-10KA2020 ⁽¹⁾
GANGED	MTX + (number of potentiometers: 2, 4, 6, 8) + ... (POT. CODE + ASSEMBLED SHAFT CODE)	Example: MTX4+CA9PH2,5-10KA2020 WT9051-BA ⁽¹⁾

(1) Note: If not all potentiometers in the set are identical, please, order potentiometers separately and indicate assembly order.

Color chart for rotor, housing and accessories

Black ⁽¹⁾	NE
White	BA
Neutral	IN
Transparent	TA
Red	RO
Green	VE
Yellow	AM
Blue	AZ
Grey	GS
Brown	MR

(1) Black is not an option for housings.

14 - Wiper

Wiper position (Standard is at 50% ± 15°)	(leave blank)
Initial or CCW	PI
Final or CW	PF
Others: following clock positions; at 3hours: P3H	PXH, ex: P3H
Wiper torque (Standard: <2 Ncm)	(leave blank)
Low torque (< 1.5Ncm)	PGB

16 - Potentiometers with assembled accessories

Assembled from front side	WT
Assembled from collector side	WTI
Accessory Reference See list of shafts and thumbwheels available	XXXX Example: 9005
Color of shaft or thumbwheel	-YY Example, white: BA

Specifications on this catalogue are for reference only; they are subject to change without notice.

DRAWINGS CA9 // CE9

Tolerances 9 mm (in mm.):

<1	±0,1
1...<5	±0,3
5...	±0,5

Model types. CA9 // CE9

CA9 H2,5 // CE9 H2,5

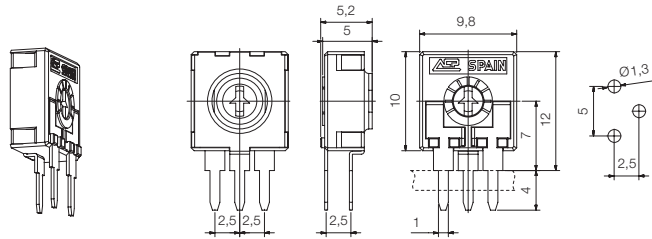

CA9 H3,8 // CE9 H3,8

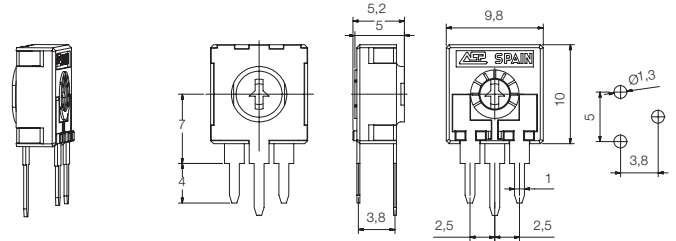

CA9 HS3,8 // CE9 HS3,8

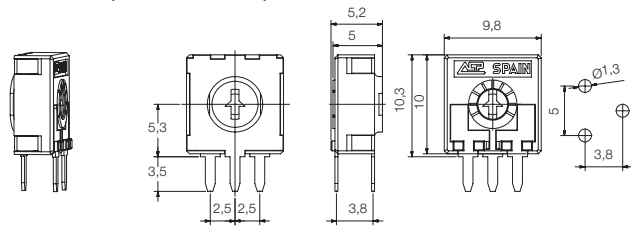

CA9 H5 // CE9 H5

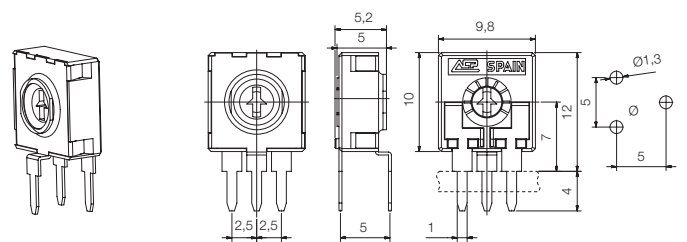

CA9 V7,5 // CE9 V7,5

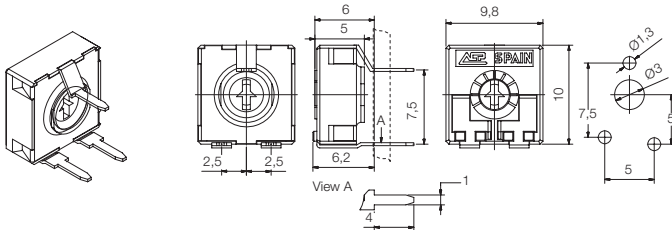

CA9 V10 // CE9 V10

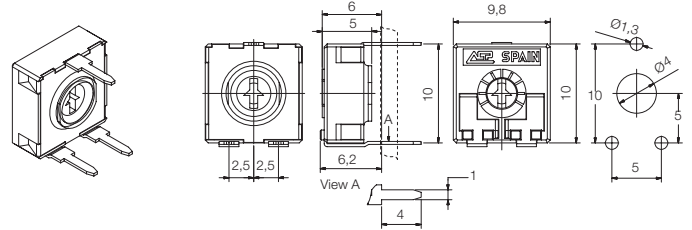

CA9 VR10 // CE9 VR10

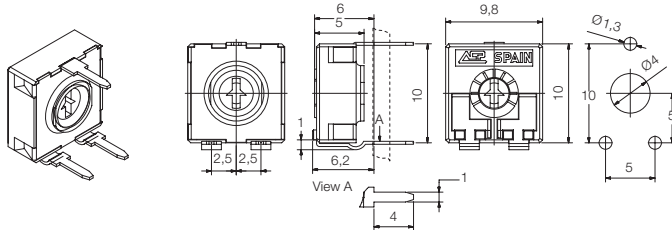

CA9 MAV10 // CE9 MAV10

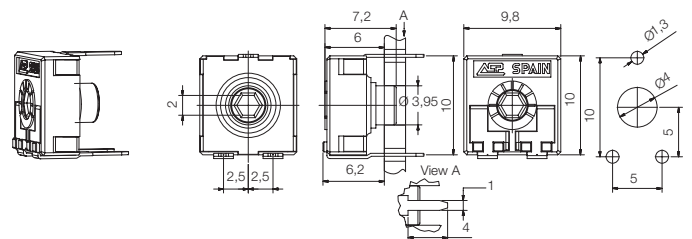

CA9 MTV10 // CE9 MTV10

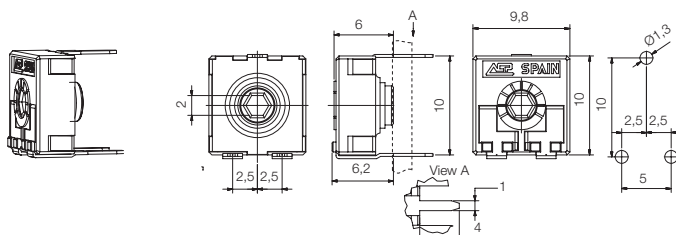

Specifications on this catalogue are for reference only; they are subject to change without notice.

DRAWINGS CA9 // CE9

Tolerances 9 mm (in mm.):

<1	±0,1
1...<5	±0,3
5...	±0,5

Thumbwheels. CA9 // CE9

9002

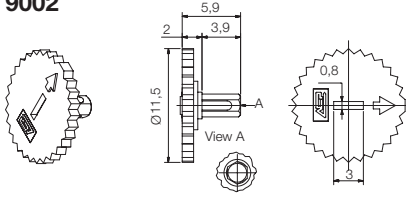

9041

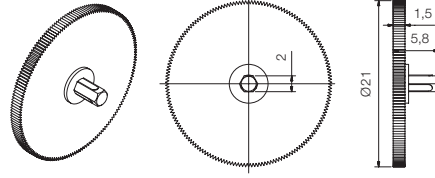

9060 For Rrotor

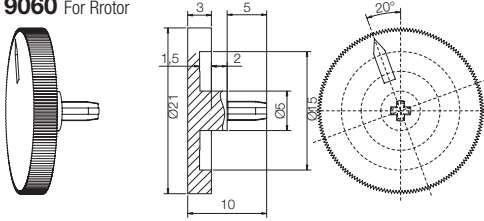

9061

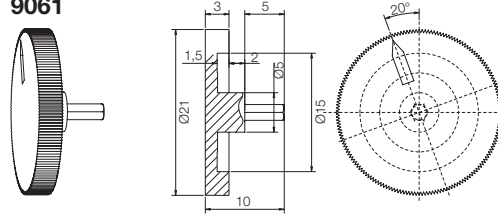

Shafts. CA9 // CE9

9004

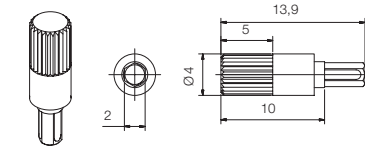

9005

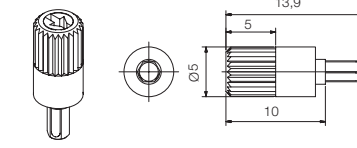

9006

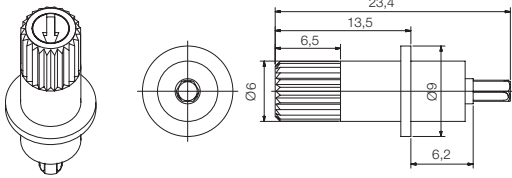

9009

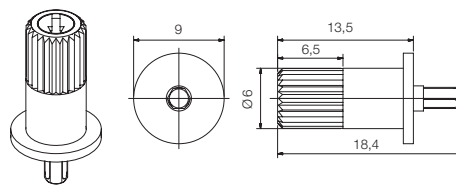

9010

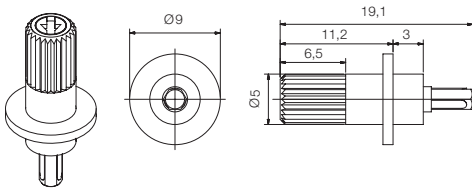

9018 For 6 potentiometers

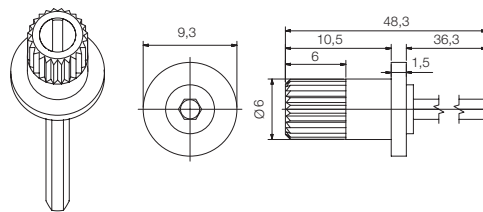

9039 For 4 potentiometers

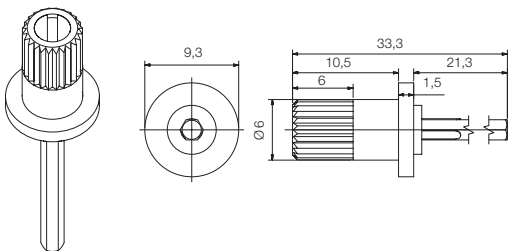

9047

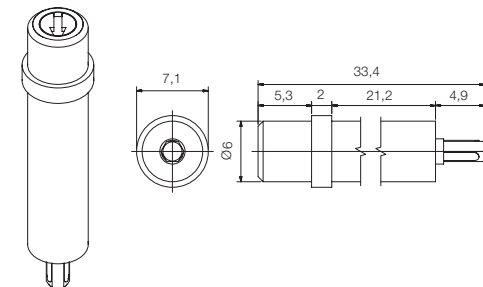

Specifications on this catalogue are for reference only; they are subject to change without notice.

DRAWINGS CA9 // CE9

Tolerances 9 mm (in mm.):

<1	±0,1
1...<5	±0,3
5...	±0,5

Shafts. CA9 // CE9

9048 For 2 potentiometers

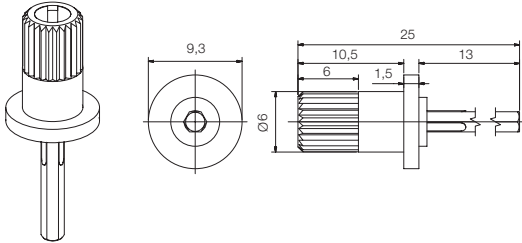

9051 For 4 potentiometers

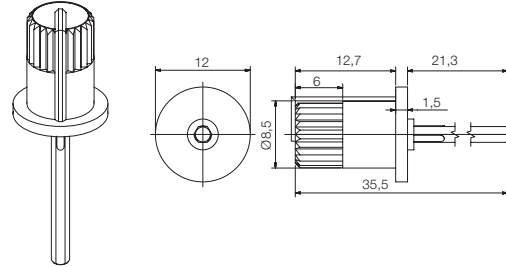

9053

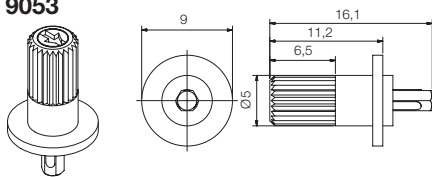

9054

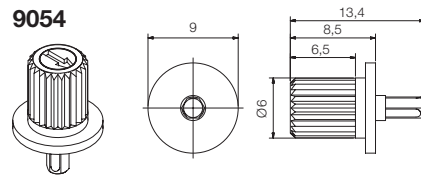

9055

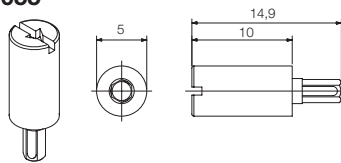

9056 For 8 potentiometers

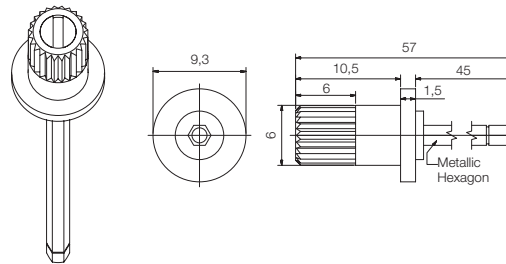

9059

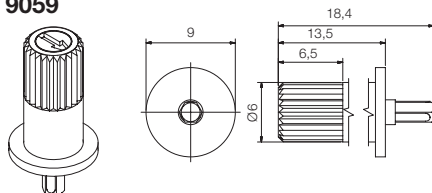

9063

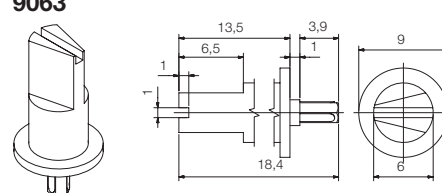

9064

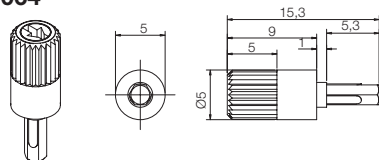

9067

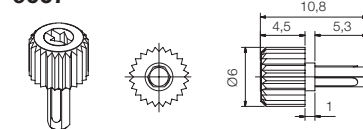

Specifications on this catalogue are for reference only; they are subject to change without notice.